



**NEW-GEN
CELERIO**



Move Smart

When you move smart, you live smart, and the Celerio gives you the ability to do both. With all-new technologies, unmatched space, and safety features which outsmart the rest, the Celerio is a partner for a smart, satisfying driving experience.

With diverse colour options, smart and stylish design, and a blend of incredible digital and engineering technology in a compact and affordable package, you can look forward to an unbeatable driving experience.





SMART SPACE

With the most spacious cabin design and 295ℓ boot space, the Celerio lets you enjoy the driving experience, trips with friends and family, and the ability to pack as much life into your car as you can.

QUALITY COMFORT

Quality and comfort are key to an awesome driving experience, and the Celerio gives you both, with smartly designed seats and surrounds geared toward your driving satisfaction.





INTELLIGENT INSTRUMENTS

The design of the instrument panel contributes to a comfortable driving experience, with easy-to-see meters and controls.

ADDING ENTERTAINMENT (GL MODELS)

The accessible and smartly placed Touchscreen Infotainment System with Bluetooth^{®**} Connectivity lets you have more fun while you drive and allows you to safely navigate and communicate. Connect easily with Apple CarPlay or Android Auto. The system also includes a reverse camera for added safety and convenience.

Smart vehicle notifications, alerts, instantaneous and average fuel consumption, fuel range, and more are displayed on this new-gen Touchscreen Infotainment System.

SMART SCENES

Large windows and a high seating position give you extensive visibility, giving you a perfect view from the front seat. This extended view you have of the road lets you make smart decisions on your drive.





SMART STORAGE

The 295ℓ boot space and low-to-the-ground tailgate let you pack smart, pack extra, and load and unload simply.

ADD AND ADJUST

Convenient hooks and smart, adjustable seat setups let you load anything you need into the boot and cabin, whatever the shape.

TAKE MORE ANYWHERE YOU GO WHILE YOU MOVE SMART.



EXTERIOR STYLING

FOR EFFICIENCY

With streamlined styling in a compact shape the Celerio makes driving a breeze.

The smooth lines and smart shape contribute to the look, but also to the efficiency, drivability, and handling of the vehicle. Every design choice and each feature contribute to the driving experience and low running cost of the Celerio.



SMART HANDLING

The compact dimensions of the Celerio not only make handling easy, but also have a compact turning radius that makes navigating tight city streets effortless.

AERODYNAMICS

The shape of the Celerio is critical to the quality of your drive. Thanks to computer-aided engineering systems and wind tunnel testing, the exterior line and underfloor airflow optimise the Celerio for improved aerodynamics and fuel-efficiency.

WHEELS

Whatever your wheel choice, you'll get a ground-hugging look with great stability and smoother airflow along the car's body for improved fuel-efficiency. GL models are styled with 15-inch alloy wheels, and the GA model with 14-inch steel wheels with a full wheel cap.

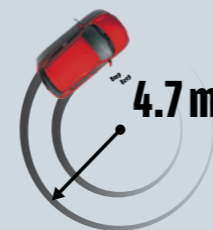

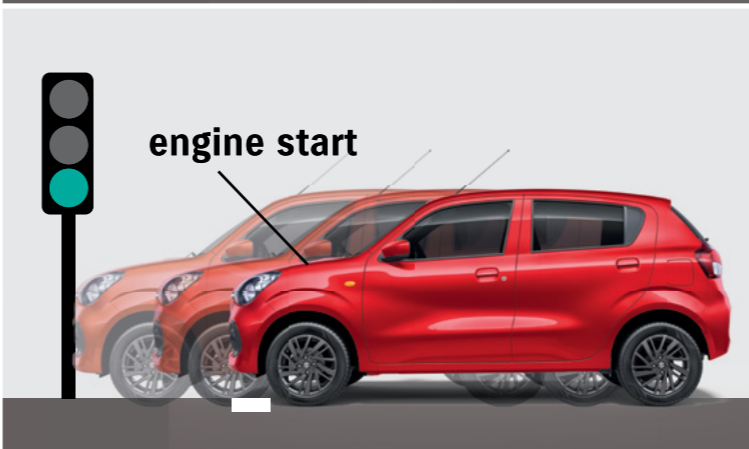
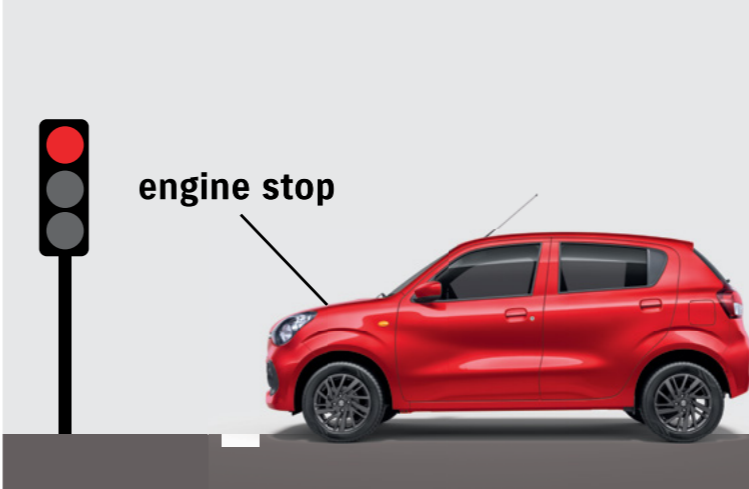

ENGINE AUTO STOP-START TECHNOLOGY

Auto Start-Stop automatically turns off the car when it is stationary and starts it up again when you want to move off. Reducing the amount of time that your engine spends idling, this technology reduces fuel-consumption, lowers emissions, and allows you drive in high-traffic situations without losing efficiency.

FUEL EFFICIENCY

At 4.2l per 100km (AMT) with lower emissions than its competitors, the Celerio gives you the satisfaction of driving smart by not only reducing your own running costs, but also contributing to a healthier environment.

SMART ENGINE TECHNOLOGY; PERFECT PERFORMANCE

NEW-GEN DUALJET ENGINE

The K10C Dualjet engine in the Celerio runs cooler, uses fuel more efficiently, and allows for a quicker throttle response, while giving you the benefits that the standard Engine Auto Stop-Start Technology brings.



SMART ABOUT SAFETY

Our safety features all contribute to the stability and safety of your Celerio, giving you peace of mind and comfort knowing that you're protected in tricky situations.

ESP - ELECTRONIC STABILITY PROGRAM

Maintain control of your Celerio in any driving conditions. ESP is a computer-controlled braking system which maintains traction on the road by controlling individual wheels. ESP enhances safety in slippery road conditions and during sudden, harsh and evasive steering manoeuvres.

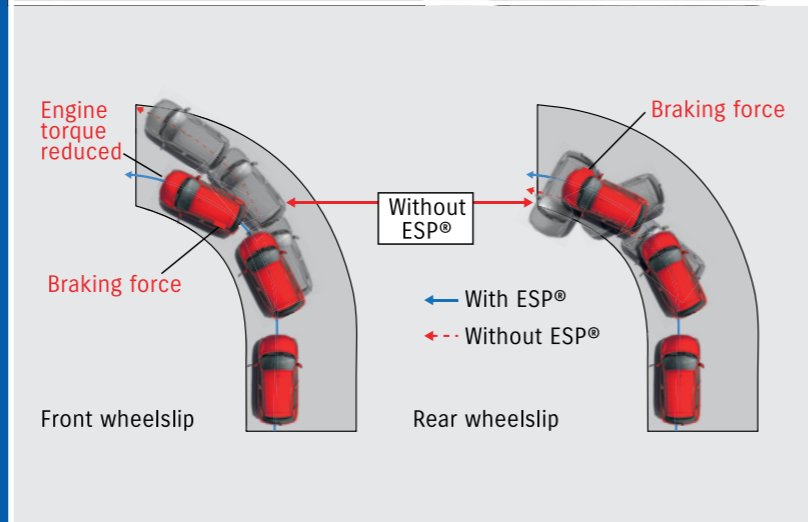

HILL HOLD CONTROL - AMT MODEL

This technology prevents you from rolling back on a hill - saving you from accidents, loss of control, or constant stalling. Suzuki engineers have perfected Hill Hold Control to bring our drivers the smartest, most effective solution.

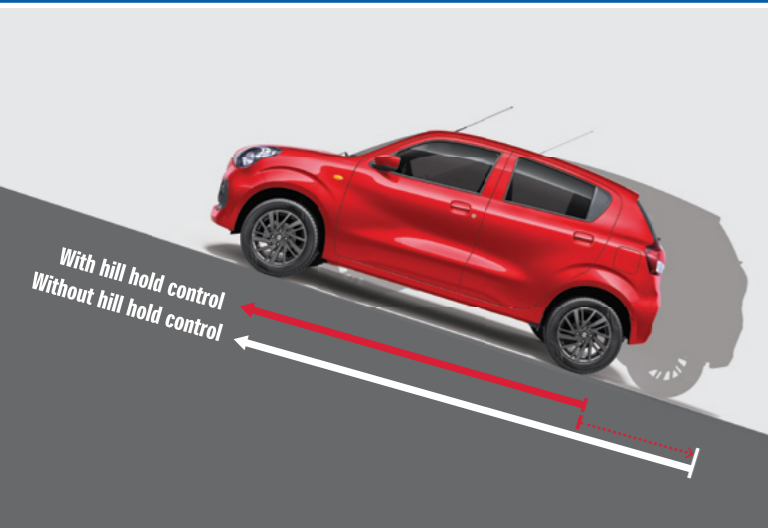

ABS WITH EBD AND BA AND SIX AIRBAGS

ABS helps to keep your wheels from locking, adding stability to any sudden evasive manoeuvres. Electronic Brake force Distribution (EBD) works with ABS to maintain control, by sending the optimum amount of braking force to the front and rear wheels.

The Celerio is equipped with six airbags, offering comprehensive protection for both the driver and passengers. Dual front airbags safeguard against frontal collisions, while side and curtain airbags, combined with side-impact beams, provide added security in side-on impacts—ensuring peace of mind and optimum safety, no matter the situation.

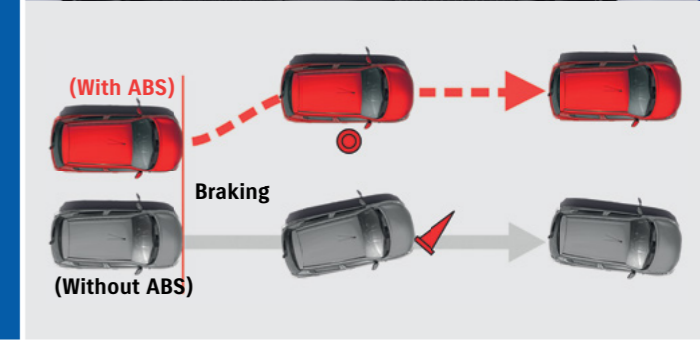

REAR PARK & REVERSE ASSIST

Have eyes where you can't see to reverse and park smart. Reverse and park with confidence using both the proximity alerts and rear-view camera (GL). Visual and audio cues notify you of distance and obstacles, helping you navigate tight spots, city parking, and reversing without the risk of damage to your vehicle.



THE FINER DETAILS:

SMART TRANSMISSION

5-SPEED MANUAL TRANSMISSION

The 5-speed manual transmission provides comfort in traffic and smooth acceleration through all five gears. Smart innovations help save fuel by minimising torque loss.

AUTOMATED MANUAL TRANSMISSION (AMT)

Combining the fuel efficiency and direct drive feel of a manual transmission with automatic gear shifting and clutch operation makes driving easier and more exciting.



SMART SUSPENSION

FRONT AND REAR SUSPENSION

Suzuki has designed the Celerio's suspension with driving comfort and handling in mind. Beyond achieving impressive performance, the Celerio also incorporates weight- and space-saving innovations.



Body structure achieving both NVH and reduced weight

Enhanced intake parts

Optimised engine mount system

Enhanced exhaust parts

Optimised suspension system

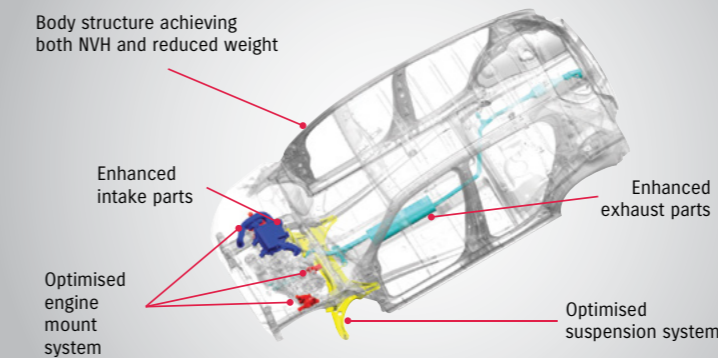

WHEELS AND TYRES

SMARTER WHEELS

All wheels are equipped with low rolling resistance tyres which achieve improved fuel efficiency without sacrificing grip, wear life or stopping distance.



SMARTER BRAKES

Enhancements to pedal ratio and booster properties optimise pedal force, deceleration, and stroke for smooth braking while innovative weight-reduction measures contribute to fuel saving.



Move Smart



MAJOR SPECIFICATIONS

Number of doors	5 doors
Engine	Petrol, 1.0ℓ Dualjet Engine with VVT
Drive system	2WD

DIMENSIONS

Overall length (mm)	3 695	
Overall width (mm)	1 655	
Overall height (mm)	1 555	
Wheelbase (mm)	2 435	
Tread	Front (mm)	1 430/1 440
	Rear (mm)	1 440/1 450
Minimum turning radius (m)	4,7	
Minimum ground clearance (mm)	170	

CAPACITIES

Seating capacity	5 persons	
Fuel tank capacity	32ℓ	
Luggage capacity	Max volume (litres)	295

ENGINE

Type	K10C	
Number of cylinders	3	
Number of valves	12	
Piston displacement (cm³)	998	
Bore x stroke (mm)	73.0 x 79.5	
Compression ratio	11.5	
Maximum output (kW/r/min)	49/5 500	
Maximum torque (Nm)	89/3 500	
Fuel distribution	Multipoint injection	
Fuel efficiency (ℓ/100km)	4.4 (MT)	4.2 (AMT)

TRANSMISSION

Type	5MT	AMT	
Gear ratio	1 st	3.545	
	2 nd	1.864	
	3 rd	1.240	
	4 th	0.906	
	5 th	0.718	0.697
	Reverse	3.272	
Final gear ratio	4.471	4.706	

CHASSIS

Steering	Rack and Pinion	
Brakes	Front	Ventilated disc
	Rear	Drum, leading and trailing
Suspension	Front	MacPherson strut with coil spring
	Rear	Torsion beam with coil spring
Tyres and wheels	165/70R14 (GA)/175/60R15 (GL)	

WEIGHTS

Kerb weight (min. / with full option) (kg)	805-830
Gross vehicle weight (kg)	1 260

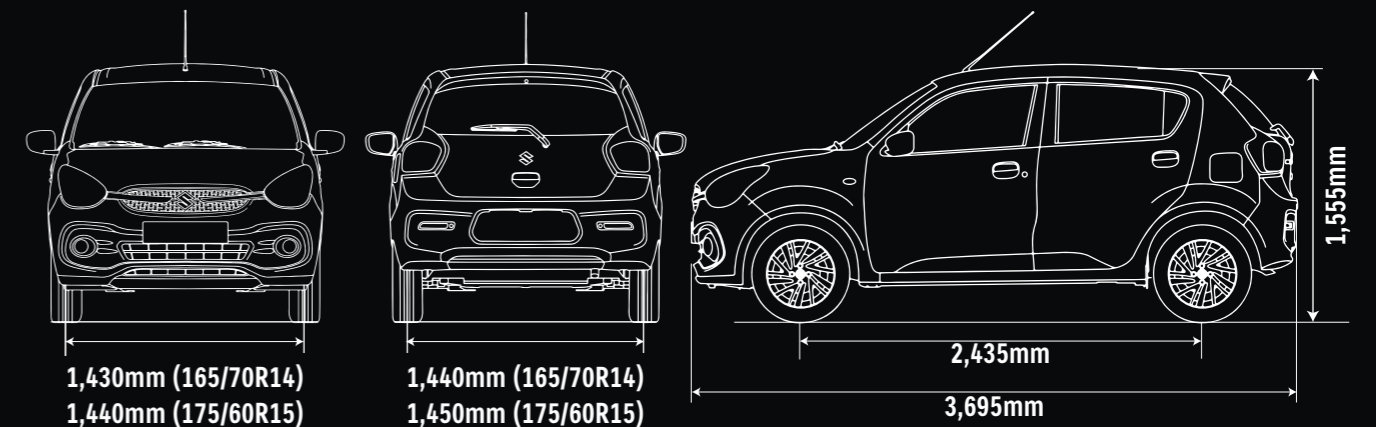

MAJOR EQUIPMENT

GRADE	GA	GL
Transmission	5MT	5MT/AMT

CHASSIS

Tyres and wheels	165/70R14 + steel wheels with full wheel cover	⊕	-
	175/60R15 + alloy wheels	-	⊕
Spare tyre and wheel	165/70R14 + steel wheel	⊕	⊕

EXTERIOR

Bumper	Body coloured	⊕	⊕
Front grille	Chrome	⊕	⊕
Outside door handles	Black	⊕	-
	Body coloured	-	⊕

VISIBILITY

Headlamps	Halogen multireflector	⊕	⊕
Fog lamps	Front	-	⊕
Rear combination lamps	Back Door Defogger	⊕	⊕
Outside door mirrors	Black	⊕	-
	Body coloured	-	⊕
	Manual adjust	⊕	-
	Electrical adjust	-	⊕
Anti-glare rear view mirror	Manual dimming	-	⊕

STEERING AND INSTRUMENT PANEL

3-spoke urethane steering wheel	Urethane	⊕	⊕
	With audio controls	⊕	⊕
	With hands-free phone control	-	⊕
	Tilt-adjust	-	⊕
Power steering		⊕	⊕
Tachometer		-	⊕

STEERING AND INSTRUMENT PANEL (CONTINUED)

Information display	Clock	⊕	⊕
	Fuel consumption	⊕	⊕
	Driving range (distance to empty)	⊕	⊕
Light-off and key reminder		⊕	⊕
Door ajar reminder		⊕	⊕
Driver's seatbelt reminder	Lamp & alarm	⊕	⊕
Meter illumination		⊕	⊕
Centre and side louvre bezels	Black	⊕	-
	Silver	-	⊕

DRIVING AMENITIES

Electric windows	Front	-	⊕
	Rear	-	⊕
Central door locking		-	⊕
Remote-control door locks	With hazard lamp answerback function	-	⊕
Air conditioner	Manual	⊕	⊕
Heater		⊕	⊕
Pollen filter		⊕	⊕
Audio	Antenna	⊕	⊕
	Front speakers	2	2
	Rear speakers	-	2
	Display audio + Bluetooth®**®	-	⊕
	Reverse camera	-	⊕

INTERIOR

Cabin lights	Front cabin light (3-position)	⊕	⊕
Sun visors	Driver's side with ticket holder and vanity mirror	⊕	⊕
	Passenger's side with vanity mirror	⊕	⊕
Assist grips	Passenger's side	⊕	⊕
	Rear x 2	⊕	⊕
Cup holder	Front x 2	⊕	⊕
Bottle holder	Front x 2	⊕	⊕
	Rear x 2	⊕	⊕
USB port	Front console	-	⊕

GRADE		GA	GL
Transmission		5MT	5MT/AMT

INTERIOR (CONTINUED)

12V accessory socket		⊗	⊗
Remote fuel lid opener		⊗	⊗
Inside door handles	Black	⊗	-
	Silver	-	⊗
Storage pockets	Front door	⊗	⊗
	Rear door	⊗	⊗

SEATS

Front seats	Head restraints (integrated type)	⊗	⊗
	Seatback pocket (passenger's side)	⊗	⊗
Rear seats	60:40-split single-fold	⊗	⊗
	Head restraints x 2 (separate type)	⊗	⊗
Seat upholstery material	Fabric	⊗	⊗

LUGGAGE AREA

Luggage shelf		⊗	⊗
---------------	--	---	---

SAFETY, SECURITY AND ENVIRONMENTAL COMPATIBILITY

ABS		⊗	⊗
ESP [Ⓢ] **		⊗	⊗
Engine Auto Stop Start system		⊗	⊗
Hill hold control		-	⊗ (AMT)
Parking sensors	Rear	⊗	⊗
Rear-view camera		-	⊗
SRS front dual airbags		⊗	⊗
SRS side airbags	Front	⊗	⊗
SRS curtain airbags		⊗	⊗
Seatbelts	Front: 3-point ELR seatbelts	⊗	⊗
	Rear: 3-point ELR seatbelts	⊗	⊗
ISOFIX child seat anchorages		⊗	⊗
Child seat tether anchorages		⊗	⊗

SAFETY, SECURITY AND ENVIRONMENTAL COMPATIBILITY (CONTINUED)

Childproof rear door locks	⊗	⊗
Immobiliser	⊗	⊗

S: Standard O: Option -: Not available

*1: Bluetooth is a registered trademark of Bluetooth SIG, Inc.

*2: ESP is a registered trademark of Daimler AG. The ESP is designed to help keep the Celerio under control.

However, its effectiveness depends on driving conditions and the state of the road surface.

(*1)(*2): Set option





ACCESSORIES

Add personality to your Celerio with a range of smart and sporty accessories* and gadgets to let you show your style while you move smart.

EXTERIOR

- 1 | **Front under body spoiler²**
Part No. 990J0M81R07-150
- 2 | **Rear under body spoiler²**
Part No. 990J0M81R07-160
- 3 | **Side under body spoiler²**
Part No. 990J0M81R07-170
- 4 | **Rear upper spoiler**
 - Paprika orange
Part No. 990J0M81R07-120
 - Pearl arctic white
Part No. 990J0M81R07-050
 - Silky silver
Part No. 990J0M81R07-060
 - Glistening grey
Part No. 990J0M81R07-070
 - Fire red
Part No. 990J0M81R07-080
 - Caffeine brown
Part No. 990J0M81R07-090
 - Speedy blue
Part No. 990J0M81R07-100
 - Midnight black
Part No. 990J0M81R07-110

¹Although all accessories are available to be ordered, the vehicle images shown may differ from the car being sold in South Africa.

²Front under body spoiler, rear under body spoiler, side under body spoiler and wheel arch kit is available as Exterior styling kit (Part No. 990J0M81R07-140)

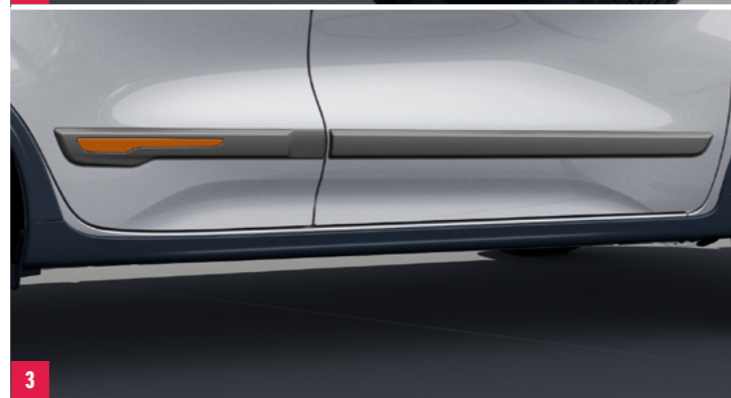

- 5 | **Wheel arch cladding¹**
Part No. 990J0M81R07-180
- 6 | **Rear mid garnish**
Part No. 990J0M81R13-070
- 7 | **Body graphics**
 - Red
Part No. 990J0M81RJ2-010 Type 1
 - Black
Part No. 990J0M81RJ2-020 Type 2
- 8 | **Fog lamp garnish**
 - Chrome
Part No. 990J0M81R13-100
 - Black
Part No. 990J0M81R13-110
- 9 | **Fog lamp garnish**
 - Paprika orange
Part No. 990J0M81R13-040
 - Pearl arctic white
Part No. 990J0M81R13-050
 - Chrome
Part No. 990J0M81R13-120
- 10 | **Body side moulding**
 - Dark grey with paprika orange
Part No. 990J0M81R01-090
 - Pearl arctic white
Part No. 990J0M81R01-010
 - Silky silver
Part No. 990J0M81R01-020
 - Glistening grey
Part No. 990J0M81R01-030
 - Fire red
Part No. 990J0M81R01-040
 - Caffeine brown
Part No. 990J0M81R01-050
 - Speedy blue
Part No. 990J0M81R01-060
 - Dark grey with pearl white
Part No. 990J0M81R01-070
 - Black with chrome
Part No. 990J0M81R01-080



INTERIOR

- 11 | **ORVM garnish**
Active and cool
Part No. 990J0M81R13-190 (GA)
Part No. 990J0M81R13-200 (GL)
Peppy and stylish
Part No. 990J0M81R13-220 (GA)
Part No. 990J0M81R13-230 (GL)
- 12 | **Door visor**
■ Standard
Part No. 990J0M81RQ0-010
■ With chrome
Part No. 990J0M81RQ0-030

- 13 | **Bumper corner protector**
■ Paprika orange
Part No. 990J0M81R17-040
■ Black
Part No. 990J0M81R17-010
■ Pearl arctic white
Part No. 990J0M81R17-020
■ Silky silver
Part No. 990J0M81R17-030

- 14 | **Mud flap** (no image)
■ Black
Part No. 72201M81R00
- 15 | **Wheel cover** (no image)
14 inch
Part No. 43250M81R10-27N
- 16 | **Body cover** (no image)
Part No. 990J0M81R02-010

- 1 | **Interior styling kit**
■ Speedy blue
Part No. 990J0M81R13-260
Active & cool
Part No. 990J0M81RPJ-050
- 2 | **Interior styling kit**
■ Paprika orange
Part No. 990J0M81R13-060
- 3 | **Door sill guard**
Twin colour
Part No. 990J0M81RP6-010
- 4 | **Carpet floor mat**
Part No. 75901M81R00
- 5 | **PVC premium mat**
Part No. 75901M81RB0
- 6 | **Boot mat**
Part No. 990J0M81RA3-010



LOOK SMART

Make a statement with a choice of seven bold, attention-grabbing shades.



FIRE RED



SPEEDY BLUE METALLIC



CAFFEINE BROWN PEARL



ARCTIC WHITE PEARL



SILKY SILVER METALLIC



GLISTERING GREY METALLIC



MIDNIGHT BLACK PEARL

FEEL SMART

Add some attitude from the ground up with 15-inch alloy* wheels

*Optional in GL & GL AMT models.



14" steel wheels with full wheel cover



15" alloy wheels



SUZUKI

COMPLETE

Suzuki understands that purchasing a new vehicle is a substantial investment. Our unwavering commitment to customer satisfaction is represented in our 'Suzuki Complete' package, which includes every aspect of after-sales support, with warranty, service plan, and roadside assistance standard.

Warranty

All Suzuki models are covered by a promotional comprehensive manufacturer's warranty against any defects for a period of 5-year/200 000km. This is supported by a six-year body corrosion warranty subject to terms and conditions. The comprehensive manufacturer's warranty is strictly reserved to new passenger cars purchased at Suzuki dealerships nationwide.

Service Plan

The Suzuki Celerio benefits from a 4-year/60 000km service plan. This plan includes the replacement of oil, the oil filter, fuel filter, brake fluid, air filter and accessory belts, but excludes tyres, brakes and other wear-and-tear items.

Service Intervals

15 000km or one year, whichever comes first.

Roadside Assistance

Every new Celerio comes with a roadside assistance plan. Some of the benefits offered by this comprehensive package include: battery and locksmith call-out services, mechanical and electrical, breakdown towing (accident towing is optional), emergency medical rescue, vehicle repatriation and a stand-by-you roadside security armed-response service.

All care is taken to ensure the accuracy of this brochure at the time of print approval. Specifications, features, prices and model availability may vary from those specified and may change without notice. Always consult your authorised Suzuki Dealer or refer to www.SuzukiAuto.co.za for the latest details on all models. SUZUKI AUTO South Africa (PTY) Ltd will not be held liable for any loss as a result of reliance on the content of this brochure, whether in negligence or otherwise. Vehicles are shown for illustrative purposes only and may not depict exact specifications. Published March 2022.

Part number 9900L-M81R0-BRO



SUZUKI AUTO SOUTH AFRICA (PTY) LTD | Tel: 0861 511 111
No.52 Saturn Crescent, Linbro Business Park, Frankenwald, Marlboro, Sandton
www.SuzukiAuto.co.za

